

CERNIERE OLEODINAMICHE

HYDRAULIC HINGES / HYDRAULIKBAND

€ E.392



V-808

- Cerniera oleodinamica con regolazione della velocità di chiusura dell'anta, stop a 0° +90° -90°.
- Hydraulic hinge with adjustment of the closing speed, stop at 0° +90° -90°.
- Hydraulikband mit Einstellung der Türschließgeschwindigkeit stop zu 0° +90° -90°.

NS - CR - AN

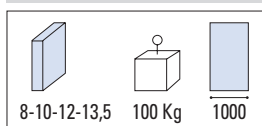
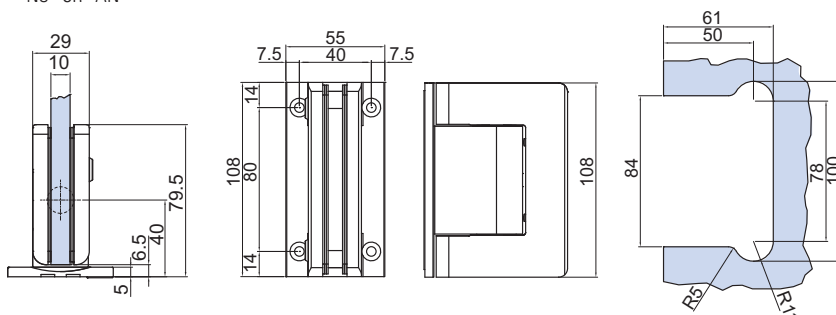

- Valvola di regolazione velocità chiusura anta
- Adjustment valve closing speed of door
- Regelsventil für die Türschließgeschwindigkeit

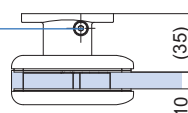

xme499-A

€ E.392



V-808-AS

- Cerniera oleodinamica con regolazione della velocità di chiusura dell'anta (con alletta spostata), stop a 0° +90° -90°.
- Hydraulic hinge with adjustment of the closing speed, (with offset fixing wing), stop at 0° +90° -90°.
- Hydraulikband mit Einstellung der Türschließgeschwindigkeit (einseitige Anschraubplatte) stop zu 0° +90° -90°.

NS - CR - AN

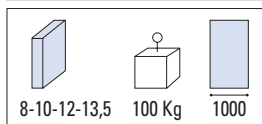
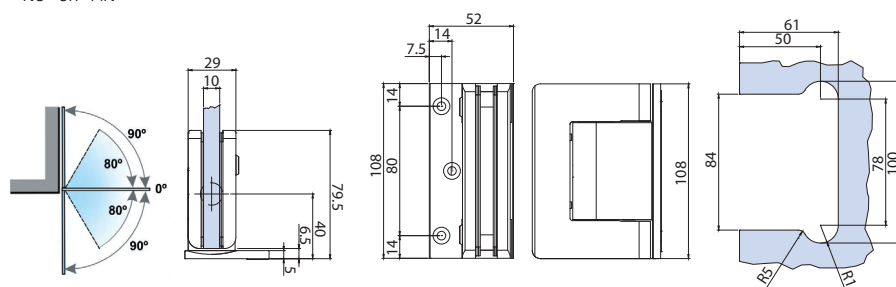

- Valvola di regolazione velocità chiusura anta
- Adjustment valve closing speed of door
- Regelsventil für die Türschließgeschwindigkeit

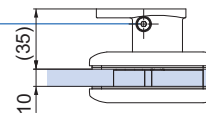

xme499-B

€ E.392



V-816

- Cerniera oleodinamica vetro/vetro 180° con regolazione della velocità di chiusura dell'anta, stop a 0° +90° -90°.
- Hydraulic hinge (glass/glass) 180° with adjustment of the closing speed, stop at 0° +90° -90°.
- Hydraulikband (Glas-Glas) 180° mit Einstellung der Türschließgeschwindigkeit stop zu 0° +90° -90°.

NS - CR - AN

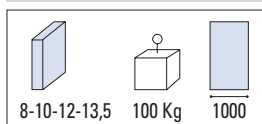
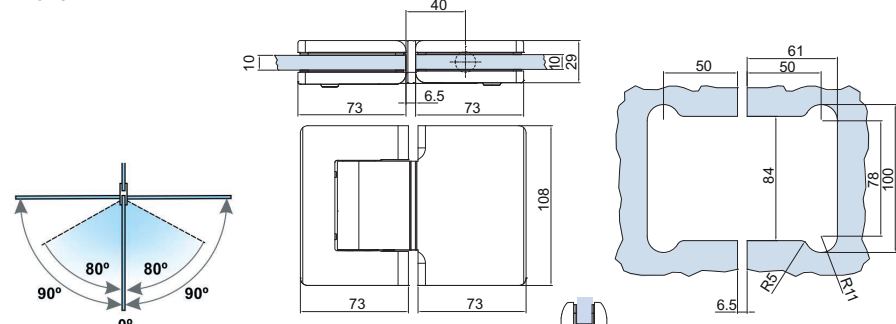

- Valvola di regolazione velocità chiusura anta
- Adjustment valve closing speed of door
- Regelsventil für die Türschließgeschwindigkeit

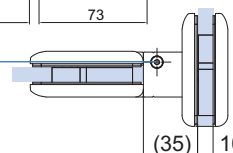

xme499-C