

MINIMAL SOFT-CLOSE COMPONENTI | COMPONENTS | EINZELTEILE

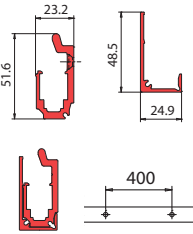

V-6450

- Binario Minimal Quadro
- Track profile Minimal Quadro
- Laufschiene Minimal Quadro



xfb-044

V-6150

- Binario Minimal Tondo
- Track profile Minimal Tondo
- Laufschiene Minimal Tondo

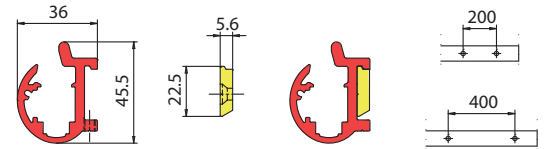

xfb-044

V-6152

- Set carrelli, stopper Soft-close e tappi per 1 anta scorrevole (per V-6150)
- Set trolley hangers, Soft-close stoppers and endcaps for 1 panel (for V-6150)
- Set Laufrollen, Soft-close Stopper und Endkappen für 1 Flügel (für V-6150)

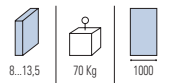
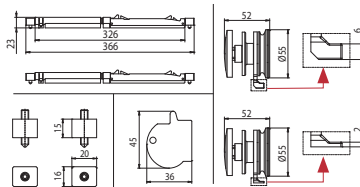

xla348

V-6022

- Set carrelli, stopper Soft-close e tappi per 1 anta scorrevole (per V-6020)
- Set trolley hangers, Soft-close stoppers and endcaps for 1 panel (for V-6020)
- Set Laufrollen, Soft-close Stopper und Endkappen für 1 Flügel (für V-6020)

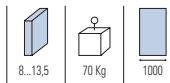
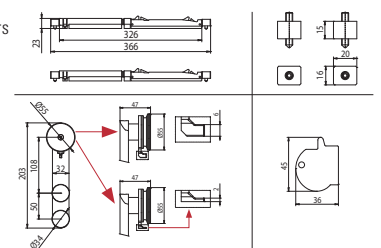

xla347 / xla348

V-6452

- Set carrelli, stopper Soft-close e tappi per 1 anta scorrevole (per V-6450)
- Set trolley hangers, Soft-close stoppers and endcaps for 1 panel (for V-6450)
- Set Laufrollen, Soft-close Stopper und Endkappen für 1 Flügel (für V-6450)

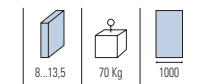
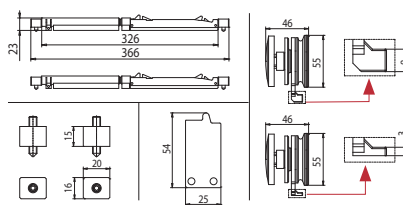

xla348

V-6352

- Set carrelli, stopper Soft-close e tappi per 1 anta scorrevole (per V-6350)
- Set trolley hangers, Soft-close stoppers and endcaps for 1 panel (for V-6350)
- Set Laufrollen, Soft-close Stopper und Endkappen für 1 Flügel (für V-6350)

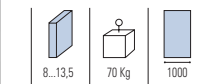
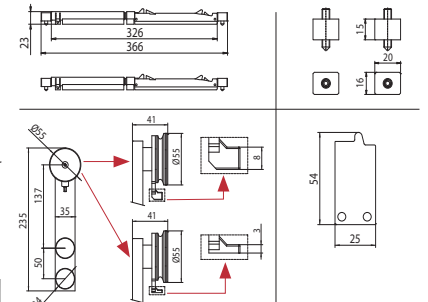

xla348 / xla349

V-6006

- Profilo e vettura per fissaggio binario a vetro (non preforato).
- Profile and cover profile for glass installation (not predrilled).
- Profil und Abdeckung für Glasmontage (nicht vorgebohrt).

V-6007

- Paio di tappi laterali per profili fissaggio a vetro V-6006.
- Pair endcaps for V-6006 profiles glass installation.
- Paar Endkappen für Profile V-6006 Glasmontage.



Cod.	Fin. Fin. Oberf.
V-6006-2000 mm	AN / CR / IXE
V-6006-3000 mm	AN / CR / IXE
V-6006-4000 mm	AN / CR / IXE
V-6006-6000 mm	AN / CR / IXE
V-6006-MIS*	AN / CR / IXE

* disponibilità taglio a misura
* cut to size
* nach Mass geschnitten

mm 1500→6000

V-6006

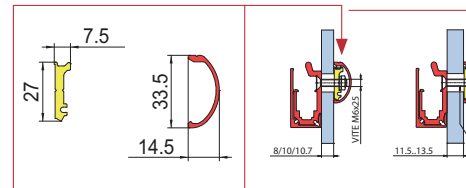

- Accorciare vite sul cantiere
- Short screw during installation
- Schrauben bauseits kürzen

V-6007



- Accorciare vite sul cantiere
- Short screw during installation
- Schrauben bauseits kürzen

xla340b / xla346c / xla348c