

# MINIMA 55 LEVER



**V-584** €►E.212



**V-585** €►E.213



- Serrature Minima 55 Lever con gancio per scorrevole o chiavistello tondo. Cilindri e contropiastre da ordinare a parte.
- Locks Minima 55 Lever with hook for sliding doors or with rounded dead bolt. Cylinders and strike plates not included, to order separately.
- Minima 55 Lever Schlösser mit Hakenriegel für Schiebetüren oder Mittelschloss mit Bolzen. Zylinder und Schließbleche nicht enthalten, separat zu bestellen.

SERRATURE

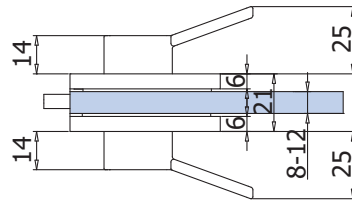
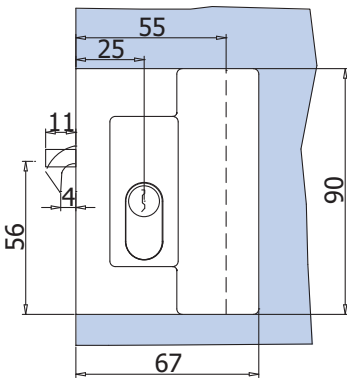

xme 496

LAVORAZIONE VETRO  
GLASS PREPARATION  
GLASBEARBEITUNG

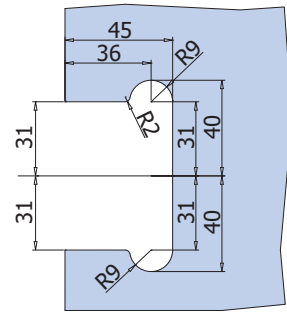

**C-020** €►E.215

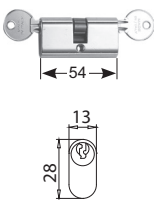

**C-021** €►E.216

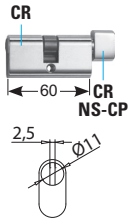

**C-019** €►E.217

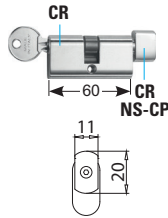

**V-569 2FLG** €►E.214

- Controserratura
- Strike box
- Gegenkasten

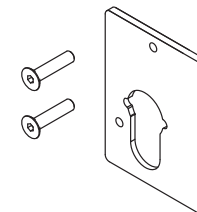
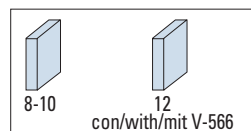
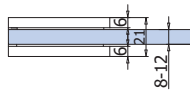
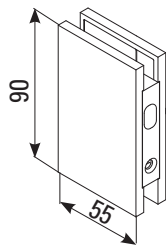
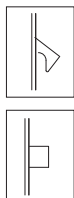

**V-566** €►E.221

- Spessore per vetro 12 mm
- Spacer for glass thickness 12 mm
- Distanzscheibe für Glasdicke 12 mm

**V-568** €►E.218

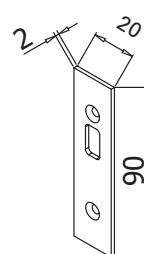

**V-567 DX** €►E.219

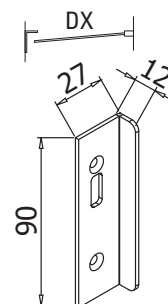

**V-567 SX** €►E.220

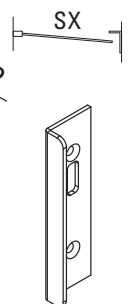

**CP**  
Cromo perla  
Chrome perla similar Alu  
Chrom perla ähnlich Alu

**NS**  
Nickel satinato  
Satin nickel  
Ähnlich Edelstahl matt

**CR**  
Cromo lucido  
Polished chrome  
Chrom glänzend