

MINIMA 55



V-564



V-565



- Serrature Minima 55 con gancio per scorrevole o chiavistello tondo.
Cilindri e contropiastre da ordinare a parte.
- Locks Minima 55 with hook for sliding doors or with rounded dead bolt.
Cylinders and strike plates not included, to order separately.
- Minima 55 Schlösser mit Hakenriegel für Schiebetüren oder Mittelschloss mit Bolzen.
Zylinder und Schließbleche nicht enthalten, separat zu bestellen.

SERRATURE CERNIERE
LOCKS AND HINGES

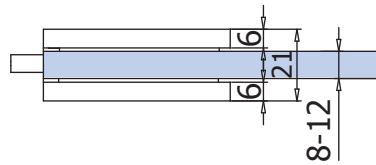
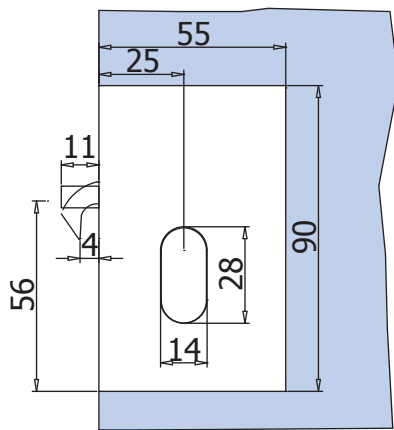

- Lavorazione vetro
- Glass preparation
- Glasbearbeitung

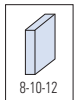
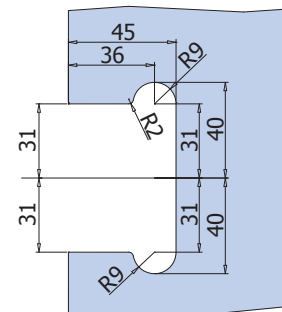

xme 496

C-010

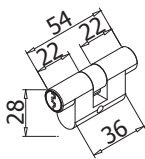

C-011

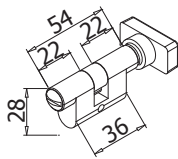

C-012

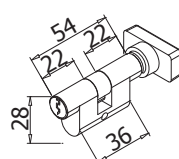

V-569 2FLG

- Controserratura
- Strike box
- Gegenkasten

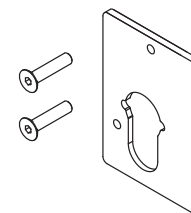
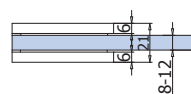
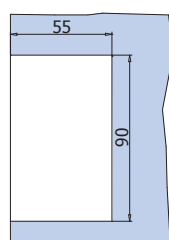
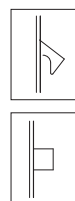

V-566

- Spessore per vetro 12 mm
- Spacer for glass thickness 12 mm
- Distanzscheibe für Glasdicke 12 mm

V-568

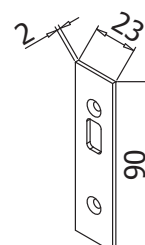

V-567 DX

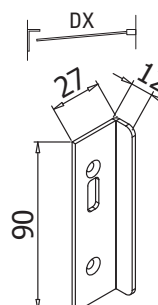

V-567 SX

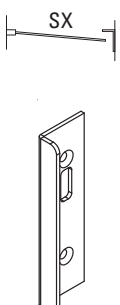

CP

Cromo perla
Chrome perla similar Alu
Chrom perla ähnlich Alu

NS

Nickel satinato
Satin nickel
Ähnlich Edelstahl matt

CR

Cromo lucido
Polished chrome
Chrom glänzend