

EVOLUTION MINI SOFT-CLOSE



V-5433



70 Kg



70 Kg

V-5453



70 Kg



80 Kg

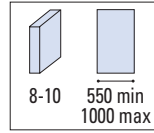

SIMPLE

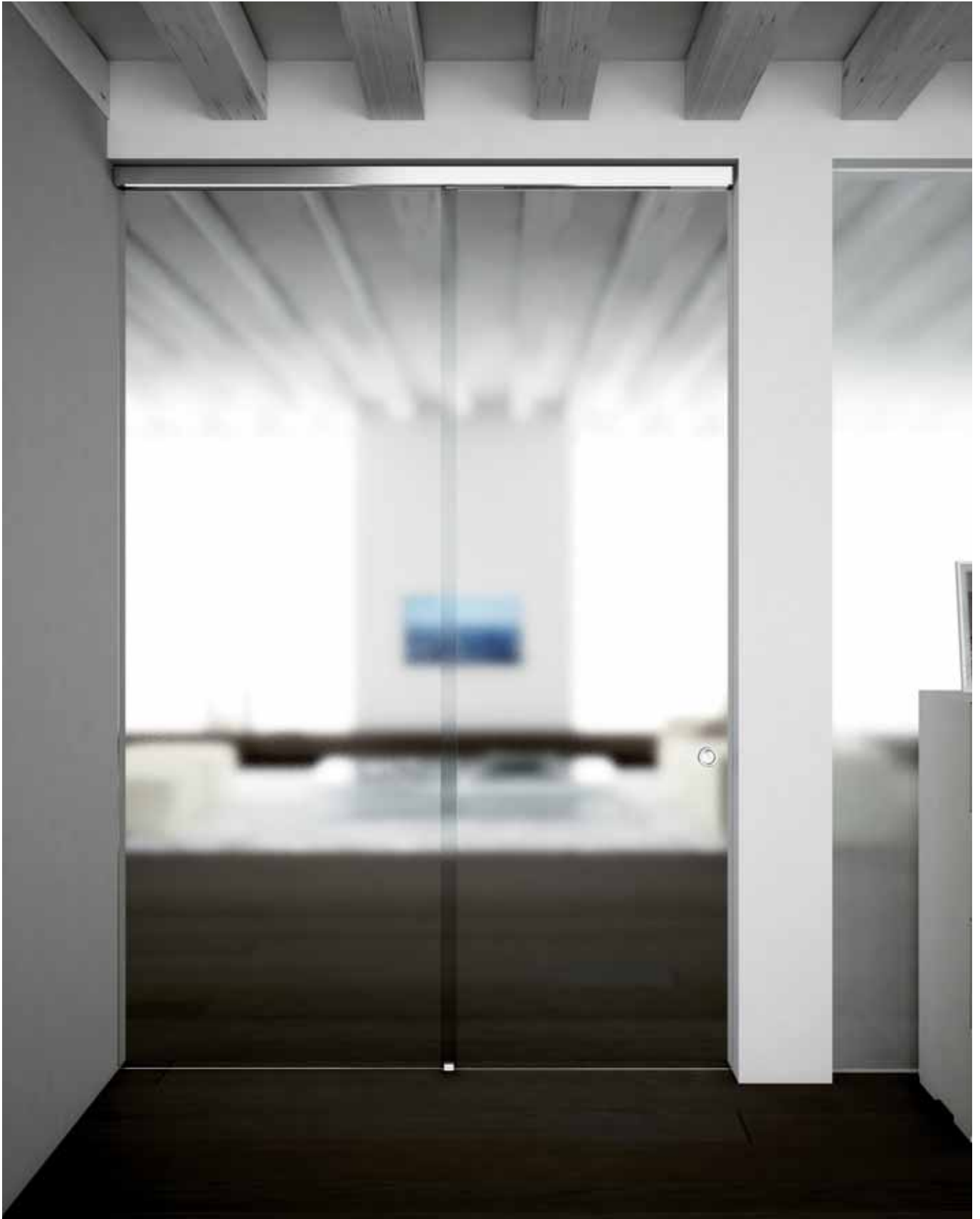

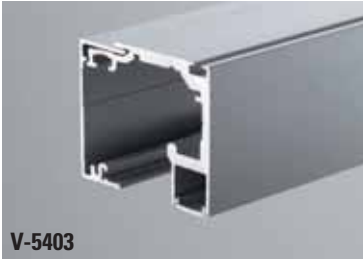
COMPONENTI / COMPONENTS / EINZELTEILE ▶ 28

V-5403

V-5152 70 Kg

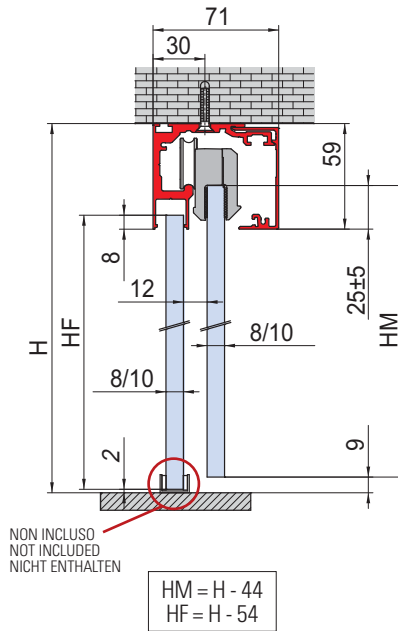
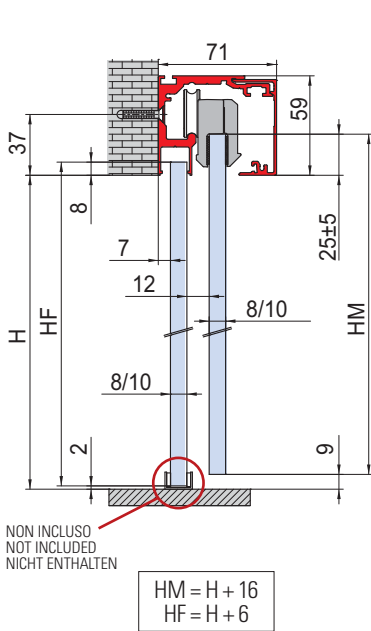
V-5406-70 C - 70 Kg
V-5406-120 - 120 Kg
V-5406 - 80 Kg

V-012
V-5411

OPTIONAL	
VP-019-MT	VP-018-MT
2	3
1000 mm	
2000 mm	
3000 mm	

• Guarnizioni per sede vetro fisso
• Gaskets for fixed glass
• Dichtungen für Seitenteil



SIMPLE

V-5433 / V-5453 SET 1

- Set per 1 anta scorrevole e vetro fisso, fissaggio a parete/soffitto
- Sliding door set with fixed panel, wall/ceiling installation
- Schiebetürset 1-flügelig mit Seitenteil, Wand-Deckenmontage

€▶ A.34 €▶ A.38

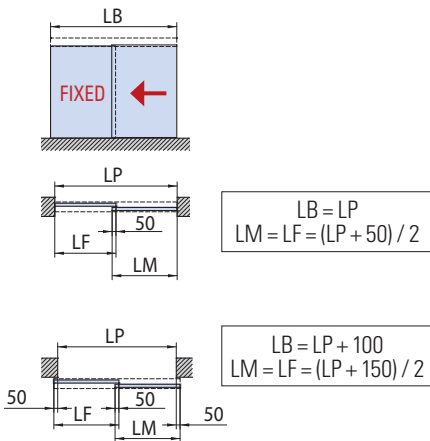

V-5433 / V-5453 SET 2

- Set per 2 ante scorrevole e vetri fissi, fissaggio a parete/soffitto
- Sliding doors set with fixed panels, wall/ceiling installation
- Schiebetürset 2-flügelig mit Seitenteil, Wand-Deckenmontage

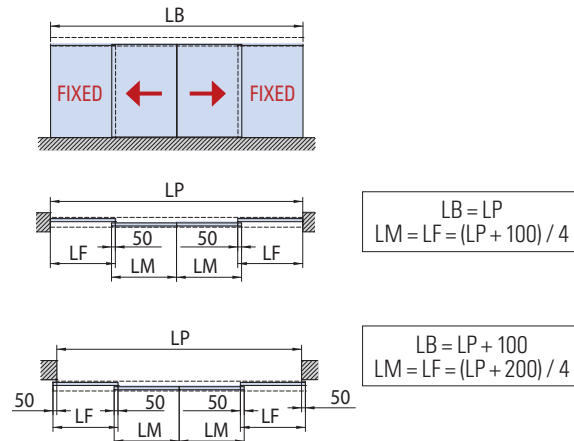
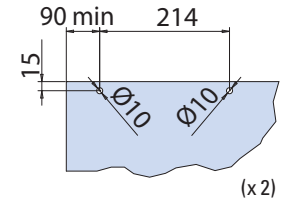
€▶ A.35 €▶ A.39

**LAVORAZIONE VETRO
GLASS PREPARATION
GLASBEARBEITUNG**

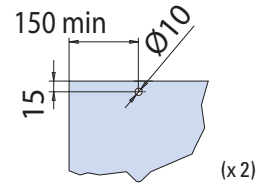
- **Fori optional** per V-5102
- **Holes optional** for V-5102
- **Bohrungen Optional** für V-5102



- **Fori optional** per V-5152
- **Holes optional** for V-5152
- **Bohrungen Optional** für V-5152

xla340c

Cod.	Fin. / Fin. / Oberf.	V-5433 / V-5453 SET 1 FIX	V-5433 / V-5453 SET 1-MIS	V-5433 / V-5453 SET 2 FIX	V-5433 / V-5453 SET 2-MIS
V-5403 L=2000 L=3000 L=4000 L=6000	AN / IXE	1	-	1	-
V-5403-MIS L=1500 → 6000	AN / IXE	-	1	-	1
V-5152	-	1	1	2	2
V-5406-70 C (V-5433)-70 Kg V-5406-80 (V-5453)-80 Kg	-	1	1	2	2
V-5411 (OPTIONAL)	AN / IXE	(1)	(1)	(1)	(1)
V-012	AN / NS	1	1	2	2

V-5400 / V-5403 / V-5450 / V-5453 / V-5440 EVOLUTION MINI SOFT-CLOSE COMPONENTI / COMPONENTS / EINZELTEILE



€ A.40



V-5400

- Guida di scorrimento Evolution Mini Soft-close completa di veletta
- Track profile Evolution Mini Soft-close with profile cover
- Führungsschiene Evolution Mini Soft-close mit Profilabdeckung

AN-IXE-NO

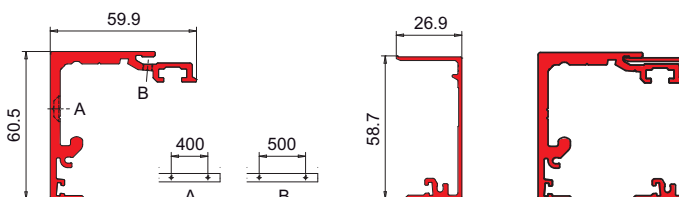

xfb-068

SIMPLE

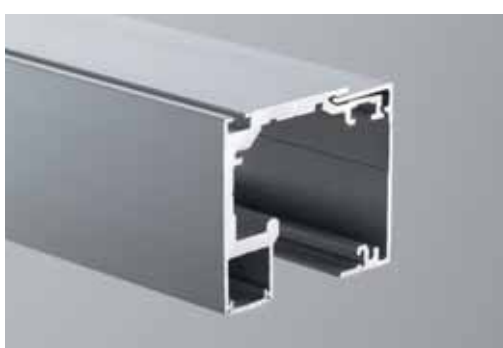

V-5403

- Binario Evolution Mini per anta scorrevole con vetro fisso laterale
- Track profile Evolution Mini for sliding panel and fixed side panel
- Laufschiene Evolution Mini für Schiebetür und Seitenteil

AN-IXE

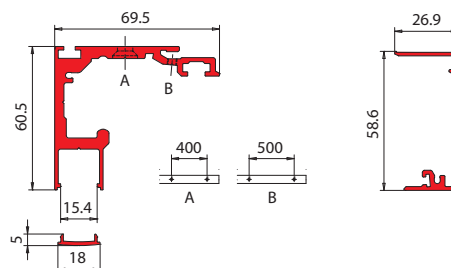

€ A.41

xfb-068

OPTIONAL	
VP-019-MT	VP-018-MT
2	3
1000 mm - 2000 mm - 3000 mm	
<ul style="list-style-type: none"> • Guarnizioni per sede vetro fisso • Gaskets for fixed glass • Dichtungen für Seitenteil 	
8	10
12	

€ A.58



V-5102

- Set accessori per 1 anta scorrevole composto da:
n° 2 carrelli, morsetti per vetro 8-10 mm,
n° 2 stoppers
- Accessories set for 1 sliding panel consisting of:
n° 2 roller carriers for 8/10 mm glass,
n° 2 stoppers
- Zubehör für 1 Schiebetür bestehend aus:
n° 2 Klemm - Laufwagen für 8/10 mm Glas,
n° 2 Stopper

120 Kg

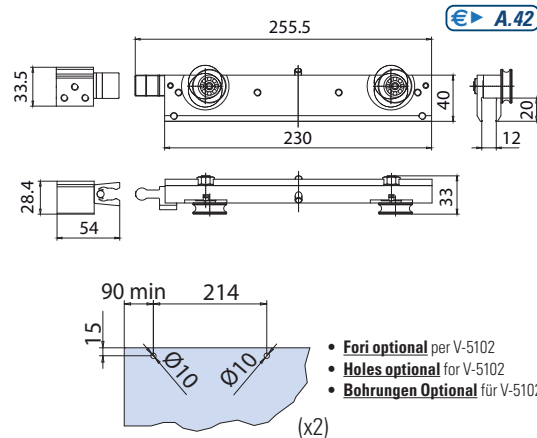

- Fori optional per V-5102
- Holes optional for V-5102
- Bohrungen Optional für V-5102

€ A.42

xme508i



V-5152

- Set accessori per 1 anta scorrevole composto da:
n° 2 carrelli, morsetti per vetro 8-10 mm, n° 2 stoppers
- Accessories set for 1 sliding panel consisting of:
n° 2 roller carriers for 8/10 mm glass, n° 2 stoppers.
- Zubehör für 1 Schiebetür bestehend aus:
n° 2 Klemm - Laufwagen für 8/10 mm Glas, n° 2 Stopper

70 Kg

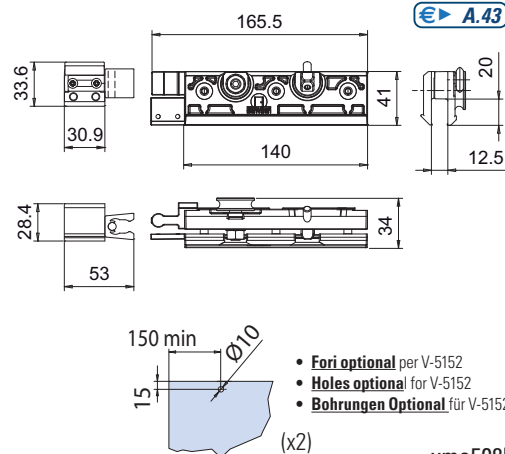

- Fori optional per V-5152
- Holes optional for V-5152
- Bohrungen Optional für V-5152

€ A.43

xme508l



soft-close
80 Kg

V-5406

- Set 2 stoppers Evolution Soft-close (per 1 anta)
- Set 2 stoppers Evolution Soft-close (for 1 sliding panel)
- Set 2 Stoppers Evolution Soft-close mit Selbsteinzug (für 1 Schiebetür)

€▶ A.45

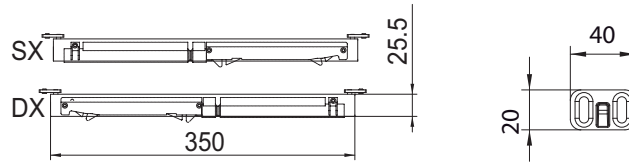

SIMPLE

xla340b



soft-close
120 Kg

V-5406-120

- Set 2 stoppers Evolution Soft-close (per 1 anta)
- Set 2 stoppers Evolution Soft-close (for 1 sliding panel)
- Set 2 Stoppers Evolution Soft-close mit Selbsteinzug (für 1 Schiebetür)

€▶ A.46

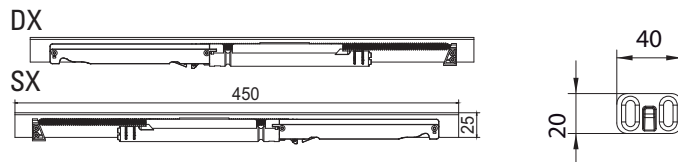

pla283z



70 Kg

V-5406-70-C

- Set 2 stoppers Evolution Soft-close (per 1 anta)
- Set 2 stoppers Evolution Soft-close (for 1 sliding panel)
- Set 2 Stoppers Evolution Soft-close mit Selbsteinzug (für 1 Schiebetür)

€▶ A.44

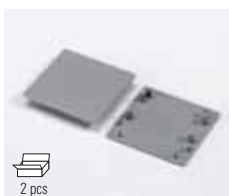
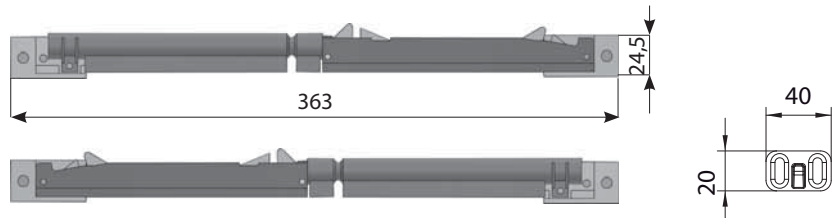

2 pcs

V-5401

€▶ A.47

- Paio tappi finali in plastica per guida a scorrimento V-5400
- Pair plastic endcaps for track profile V-5400
- Paar Endkappen aus Kunststoff für Laufschiene V-5400

AN - IXE

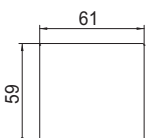

xla340b



2 pcs

V-5411

€▶ A.48

- Paio tappi finali in alluminio per guida a scorrimento V-5403
- Pair aluminium endcaps for track profile V-5403
- Paar Endkappenn aus Aluminium für Laufschiene V-5403

AN - IXE

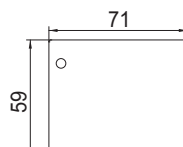

xla340b

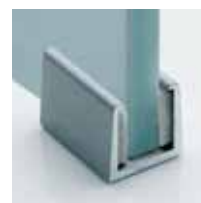

V-012

€▶ A.50

- Guida a pavimento per scorrevole con feltrini per vetro 8 e 10 mm
- Floor guide with felt strips for glass sliding door a 8 and 10mm
- Bodenführung mit Filzgleiter für Glas 8 und 10 mm

AN - NS

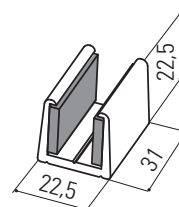

- Altri modelli disponibili a pag. 174
- Other models available on page.174
- Weitere Modelle auf Seite 174

V-5400 / V-5403 / V-5450 / V-5453 / V-5440 EVOLUTION MINI SOFT-CLOSE

COMPONENTI / COMPONENTS / EINZELTEILE



SIMPLE



V-5107 € A.49

- Set per spessori vetro 12 - 12,7 - 13,5 (per 2 pinze V-5102)
- Set spacers for glass thickness 12 - 12,7 - 13,5 (for 2 clamps V-5102)
- Set distanzscheiben für Glasdicke 12 - 12,7 - 13,5 (für 2 Klemm-Laufwagen V-5102)

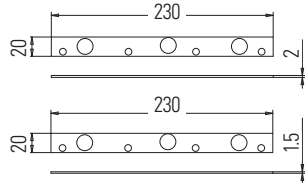
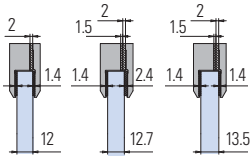

xla209b

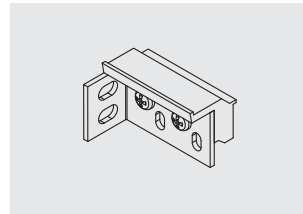

V-5112 € A.79

- N° 1 Staffa evolution autoportante reversibile DX-SX per fissaggio laterale binario V-5403/muro
- 1 pcs bracket for side fixing evolution profile V-5403
- 1 Stück winkelprofil für Seitliche Wandbefestigung Evolution Laufschiene V-5403

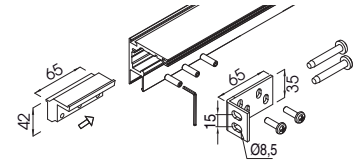
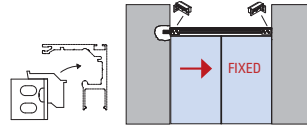

xme146



V-5307 € A.60

- Set staffe per fissaggio carrelli Evolution V-5102 con pannello legno
- Pair suspension plates hanger for Evolution clamps V-5102 with wooden doors
- Paar Winkel für Evolution Laufwagen V-5102 mit Holzüren

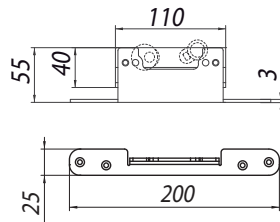
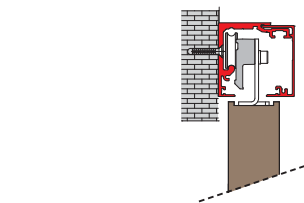

xla355

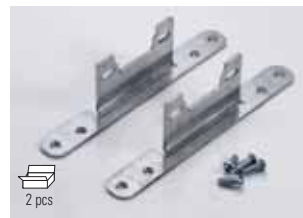

V-5507 € A.61

- Set staffe per fissaggio carrelli Evolution V-5152 con pannello legno
- Pair suspension plates hanger for Evolution clamps V-5152 with wooden doors
- Paar Winkel für Evolution Laufwagen V-5152 mit Holzüren

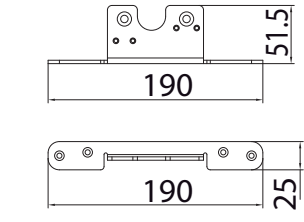
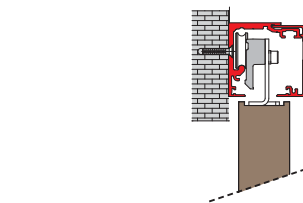

xme508f

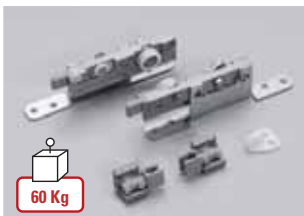

V-5142 € A.59

- Set accessori per 1 anta scorrevole in legno composto da: 2 carrelli, morsetti per porte legno. 2 stopper
- Accessory set for 1 sliding wooden door panel consisting of 2 roller carriers for wooden door, 2 stoppers
- Zubehör komplett für 1 Holz Schiebetür bestehend aus: N° 2 Klemm - Laufwagen für Holzür. 2 Stoppers

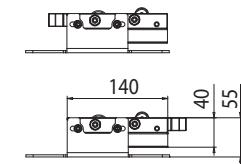
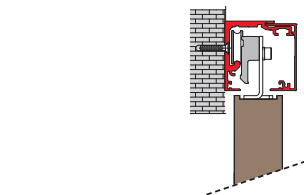

xla355

V-2014-MIX € A.196

- Canalina per vetro fisso escluso guarnizioni
- U channel for fixed panel, gaskets not included
- U Profil für Seitenteil Dichtungen nicht inkl

AN - IXE

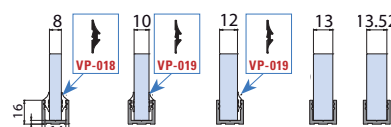

Cod.	Fin./Fin./Oberf.
V-2014-2000 mm	AN / IXE / NO
V-2014-3000 mm	AN / IXE / NO
V-2014-6000 mm	AN / IXE / NO

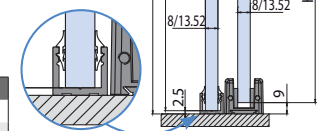

FB044-E



V-5404 € D.163

- Profilo portante PPS Evolution per vetro fisso/scorrevole/porta
- Top profile PPS Evolution for fixed/sliding/pivot door
- PPS Evolution profil für Trennwand/Schiebetür/Drehtür

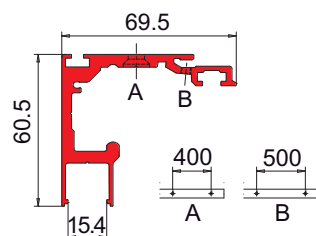

xfb-068

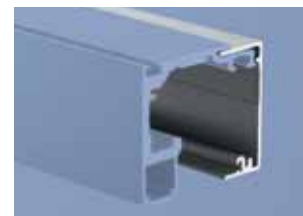

V-5405 € D.164

- Velella di copertura per tratto con porta scorrevole
- Cover profile for sliding door section
- Profilabdeckung für Schiebetür

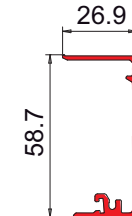

xfb-068

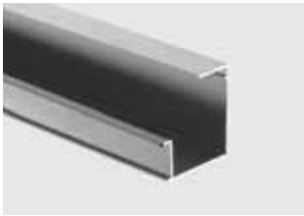

V-5407

- Veletta di chiusura per tratto con vetro fisso o porta
- Cover profile for fixed glass/pivot door section
- Sichtschutzprofil für Trennwand/Drehtür AN

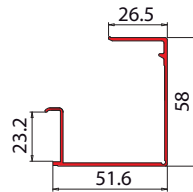

€▶ D.165

xfb-068



V-2005

- Profilo a scatto per chiusura profilo superiore
- Clips profile for aluminium top profile
- Sichtschutzprofil für Laufschiene AN

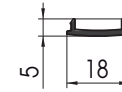

€▶ D.166

xfb-068



SIMPLE



V-6006

- Profilo e veletta per fissaggio binario a vetro (non preforato)
- Profile and cover profile for glass installation (not predrilled)
- Profil und Abdeckung für Glasmontage (nicht vorgebohrt) AN - IXE

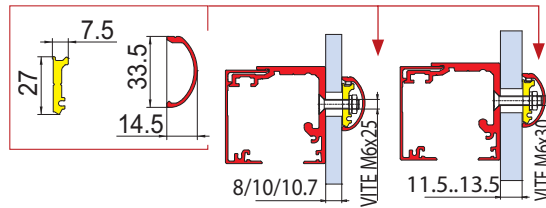

€▶ A.54

xla340d

V-6007

- Paio di tappi laterali per profili fissaggio a vetro V-6006
- Pair endcaps for V-6006 profiles glass installation
- Paar Endkappen für Profile V-6006 Glasmontage AN - IXE

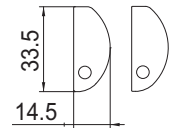

€▶ A.55

xla340d

Cod.	Fin./Fin./Oberf.
V-6006-2000 mm	AN / IXE
V-6006-3000 mm	AN / IXE
V-6006-4000 mm	AN / IXE
V-6006-6000 mm	AN / IXE
V-6006-MIS*	AN / IXE

* disponibilità taglio a misura mm 1500→6000
* cut to size mm 1500→6000
* nach Mass geschnitten mm 1500→6000



V-012-EVO

- Guida a pavimento regolabile per vetro 8-10-12 mm
- Floor guide adjustable for glass 8-10-12 mm
- Bodenführung verstellbar für Glas 8-10-12 mm AN-NS-NO-CR

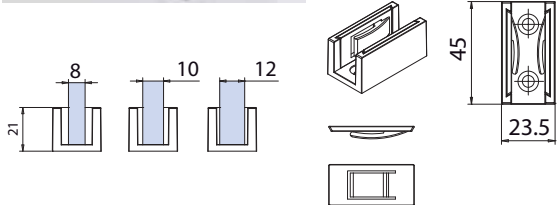

€▶ A.51

v-012new



V-5408

- Spazzolina per guida di scorrimento V-5400/V-5403
- Brush seal for track profile V-5400/V-5403
- Bürstenprofil für Laufschiene V-5400/V-5403

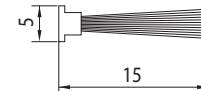

€▶ A.56

xla340B



V-5108

- Perno superiore
- Top pin
- Oberer zapfen eckig
- Asse rotazione porta
- Axe pivot door
- Achse Drehtür
- Regolazione ± 3 mm.
- Adjustment ± 3 mm.
- Verstellung ± 3 mm.

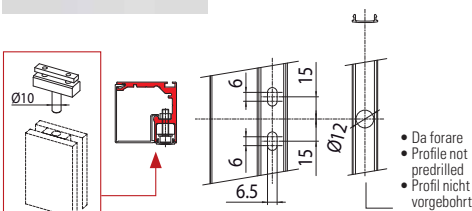

€▶ D.173

xme221C



V-5109

- Battuta per porta singola
- Single stop for pivot door
- Anschlag für Drehtür AN

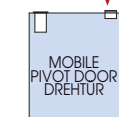
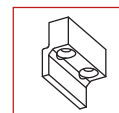

€▶ D.174

xme221C



P-F08

- Guida a pavimento per ante in legno
- Floor guide for sliding wooden panel
- Bodenführung für Schiebetüren aus Holz

€▶ A.57