

TP-401

STIPITE PORTA BATTENTE / DOOR FRAME FOR HINGED DOOR / ALUZARGE

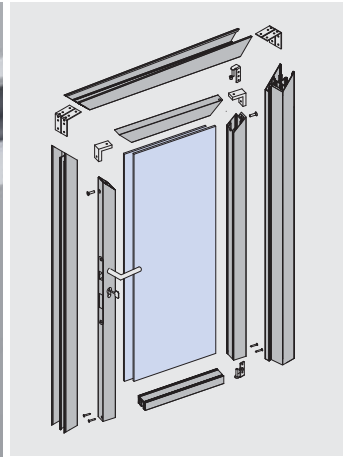

STIPITI SU VETRO

TP-401 €>D.100

- Stipite porta battente
- Door frame for hinged door
- Aluzarge

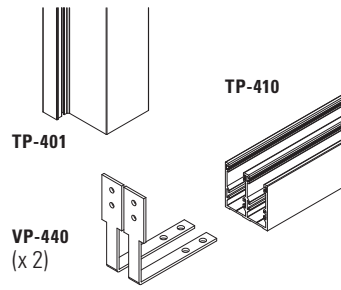
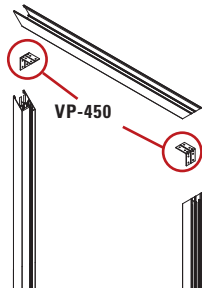
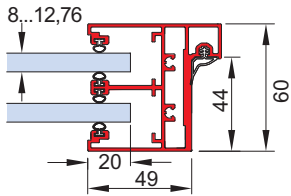

TP-405 €>D.107

- Porta battente intelaiata
- Framed glass door
- Flügelrahmen

- Senza regolazione
- Without adjustment
- Ohne Verstellung
- Con regolazione
- With adjustment
- Mit Verstellung

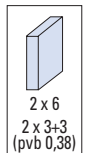
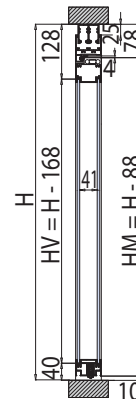
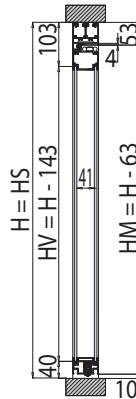
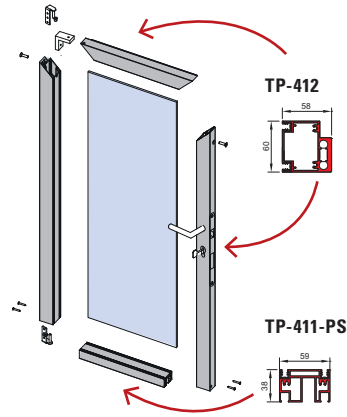
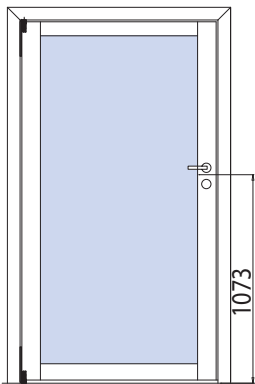

TP-411-PS €>D.109

- Fresatura per regolazione a cura del cliente
- Milling for adjustment by the customer
- Fräsung für Verstellung bauseits

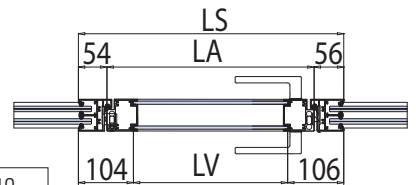
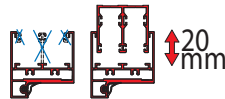
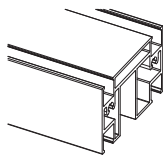
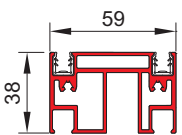

LA = LS - 110
LV = LS - 210
TP - 411 = LA - 116

TP-412 €>D.108

