



EASY FRAME TELESCOPICO SINCRO



PO-220

TRASCINAMENTO SINCRO CON CINGHIA
SINCRO DRAGGING SYSTEM WITH TOOTHED BELT
SINCRO MITNEHMER KIT MIT ZAHNRIEMEN

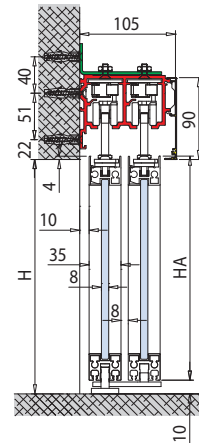
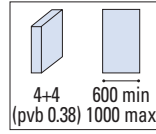

$$HA = H - 6$$

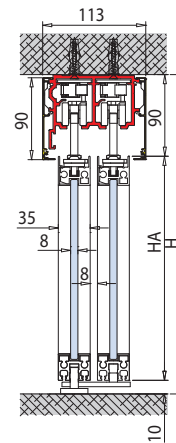

$$HA = H - 100$$

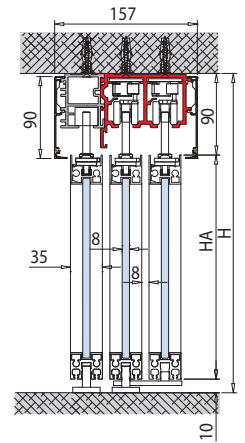

$$HA = H - 100$$

PO-220 SET 1

€ ▶ A.492

- Sistema per 2 ante scorrevoli intelaiate telescopiche con kit di trascinamento Sincro, fissaggio a soffitto
- Telescopic sliding door system 2-ways with Sincro dragging mechanism, ceiling installation
- Teleskopisches Schiebetürsystem 2-läufig mit Sincro Mitnehmer Kit, Deckenmontage

PO-220 SET 2

€ ▶ A.493

- Sistema per 2 ante scorrevoli intelaiate telescopiche con kit di trascinamento Sincro, fissaggio a parete
- Telescopic sliding door system 2-ways with Sincro dragging mechanism, wall installation
- Teleskopisches Schiebetürsystem 2-läufig mit Sincro Mitnehmer Kit, Wandmontage

PO-220 SET 1 • Soffitto • Ceiling • Decke
PO-220 SET 2 • Parete • Wall • Wand

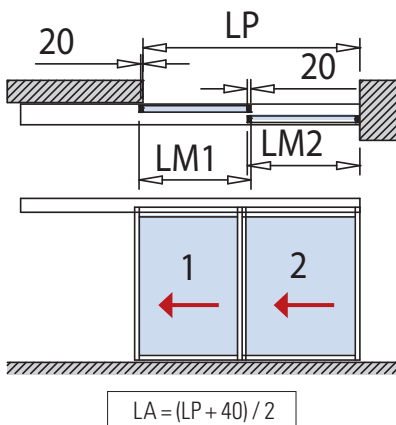

PO-225 SET 1

€ ▶ A.496

- Sistema per 2 ante scorrevoli intelaiate telescopiche e vetro fisso, con kit di trascinamento Sincro, fissaggio a soffitto
- Telescopic sliding door system 2-ways and fixed panel, with Sincro dragging mechanism, ceiling installation
- Teleskopisches Schiebetürsystem 2-läufig mit Seitenteil, mit Sincro Mitnehmer Kit, Deckenmontage

PO-225 SET 1 • Soffitto • Ceiling • Decke

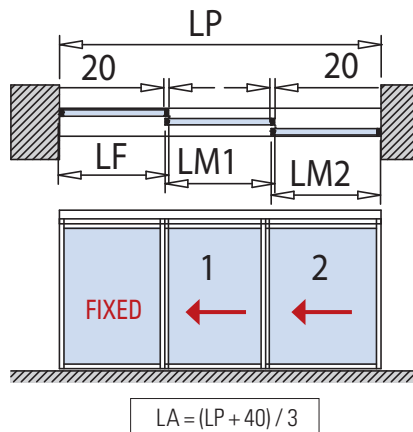

- Con ante intelaiate
- With aluminium panels
- Aluminium Flügelrahmen

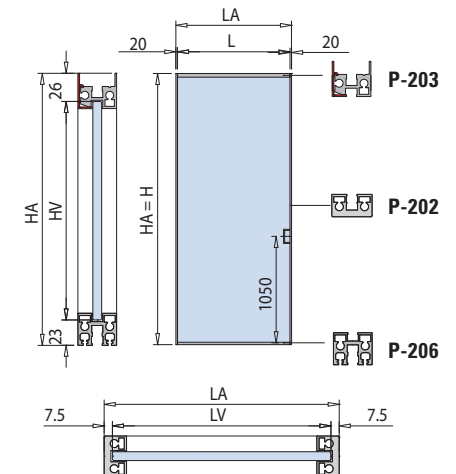

$$HV = HA - 49$$

$$LV = LA - 15$$

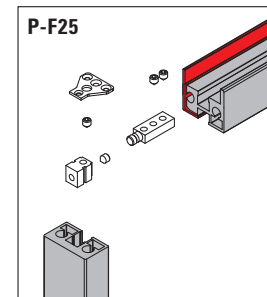

xme353

COMPONENTI / COMPONENTS / EINZELTEILE

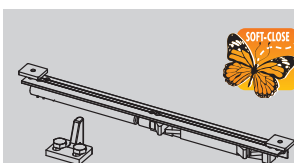

Trascinamento con cinghia
Dragging mechanism
with toothed belt
Mitnehmer Kit
mit Zahnriemen

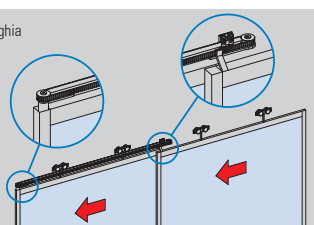

PO-238 OPTIONAL € ▶ A.498