

BALCONGLAS FALCE PARK-ISO

€▶ C.321

SISTEMA SENZA CANALINA / SYSTEMS WITHOUT BOTTOM GUIDE / SYSTEM OHNE BODENFÜHRUNG

- Sistema a pannelli mobili in vetro, impacchettabili senza la baia di parcheggio, senza canalina a terra, con profili per anta intelaiata, misure standard per anta max 1000 x 3000 mm da tagliare cliente.
- Slide and turn system, without floor channel and without parking bay, with profiles for framed glass door, standard measures up to 1000 x 3000 mm, cut by installer.
- Schiebe-Dreh-Systeme mit beweglichen Glasmodulen ohne Parkraum, ohne Bodenschiene. Flügelrahmen für standard Tür max 1000 x 3000 mm. Schnitt bauseitig



- Indicare sempre il verso di apertura e lo spessore vetro
- Please specify always opening direction and glass thickness
- Bitte immer Öffnungsrichtung und Glasdicke angeben

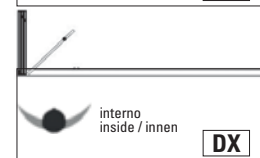
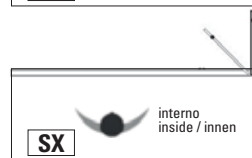
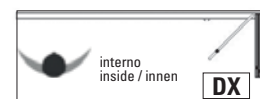
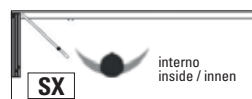

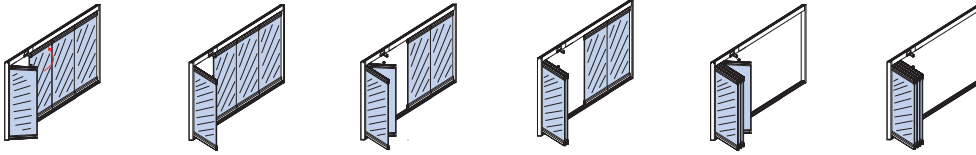

3,3-14-3,3	70 Kg	800 max
------------	-------	---------

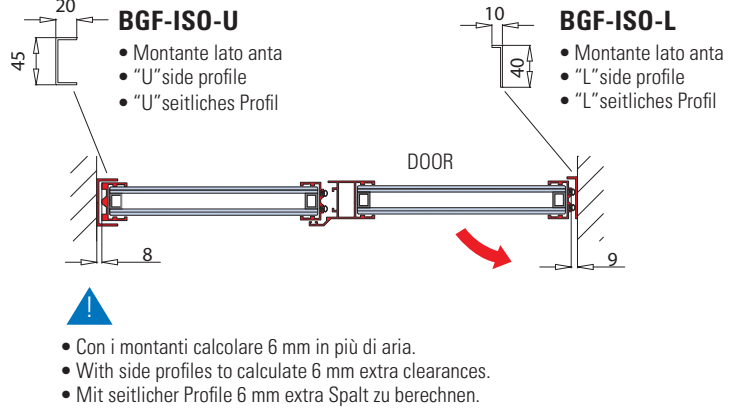
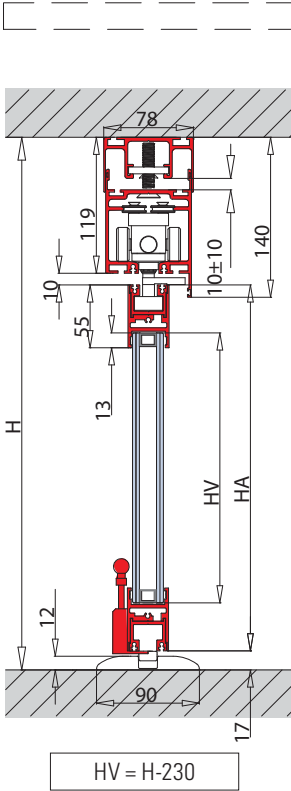

BG-ISO-PARK 2 (LB MAX = 2000 mm)	A B
BG-ISO-PARK 3 (LB MAX = 3000 mm)	A B C
BG-ISO-PARK 4 (LB MAX = 4000 mm)	A B C C
BG-ISO-PARK 5 (LB MAX = 5000 mm)	A B C C C
BG-ISO-PARK 6 (LB MAX = 6000 mm)	A B C C C C

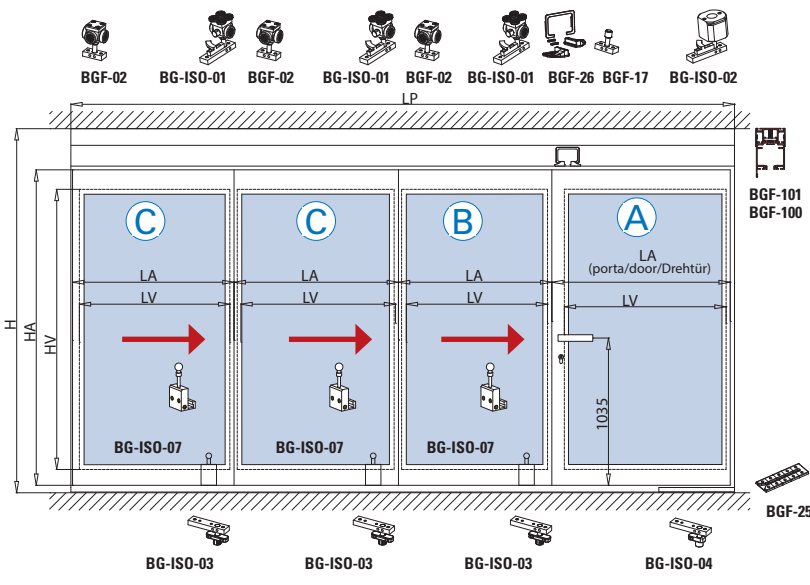

- Lavorazione montante porta per serratura.
- Vertical door Profile preparation for lock.
- Drehtür Profilbearbeitung für Schloss.
- Lavorazione montante anta per contro-serratura.
- Vertical sliding panel preparation for lock's strike plate.
- Schiebeflügel Profilbearbeitung für Schliessblech.

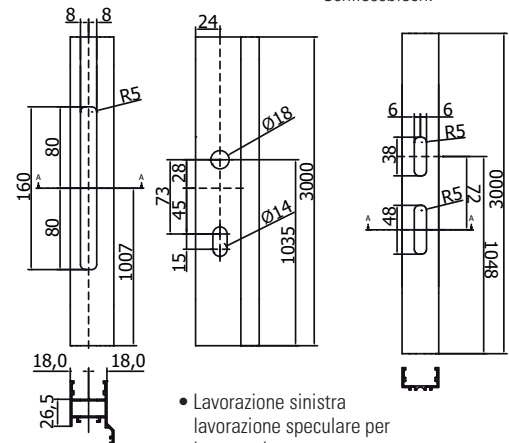

- Lavorazione sinistra lavorazione speculare per la porta destra.
- Left. For right reflecting preparation.
- Links. Für Rechts Spiegelbildlich Bearbeitung.

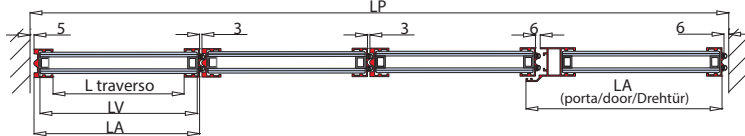

LP Passaggio luce Clear opening width Lichte Durchgangsbreite	LA = LV Larghezza ante = Larghezza vetro Panel width = Glass width Flügelbreite = Glasbreite	H Altezza passaggio luce Clear opening height Lichte durchgangshöhe	HV Altezza vetro Glass height Glashöhe	HA Altezza anta Door height Tür Höhe
---	--	---	--	--

BALCONGLAS FALCE PARK-ISO

COME USARE MY METALGLAS / HOW TO USE MY METALGLAS / WIE MAN BENUTZT MY METALGLAS

1

INSERIRE LE MISURE DEL TUO VANO E LE ANTE DESIDERATE
ENTER THE MEASUREMENTS OF YOUR OPENING AND THE DOORS YOU REQUIRE
GEBEN SIE DIE MASSE IHRER ÖFFNUNG EIN UND DIE ERFORDERLICHEN TÜREN

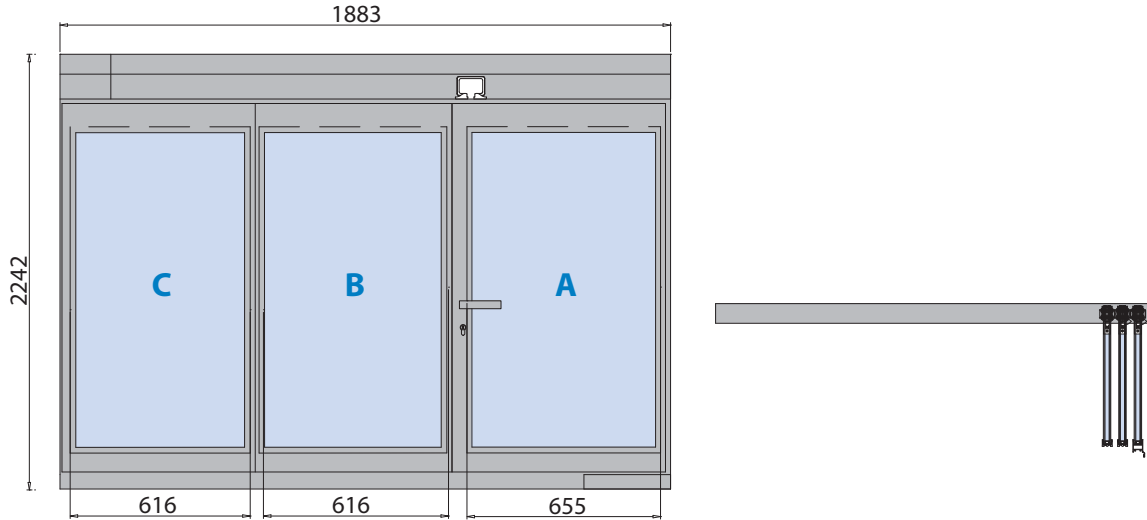

2

SI OTTENGONO LE MISURE DEI VETRI AUTOMATICAMENTE
THE MEASUREMENTS OF THE GLASS WILL BE GENERATED AUTOMATICALLY
DIE ABMESSUNGEN DES GLASES WERDEN AUTOMATISCH BERECHNET

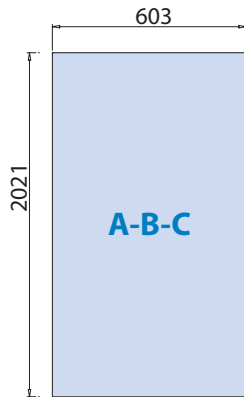

3

SI OTTENGONO LE DISTINTE DI TAGLIO DEI PROFILI, DA ABBINARE AGLI ACCESSORI
THE CUTTING SPECIFICATIONS OF THE PROFILES ARE OBTAINED, FOR MATCHING WITH THE ACCESSORIES
SIE ERHALTEN EINE SPEZIFIKATION DER PROFILLÄNGEN ZUM ABGLEICHEN MIT DEM ZUBEHÖR

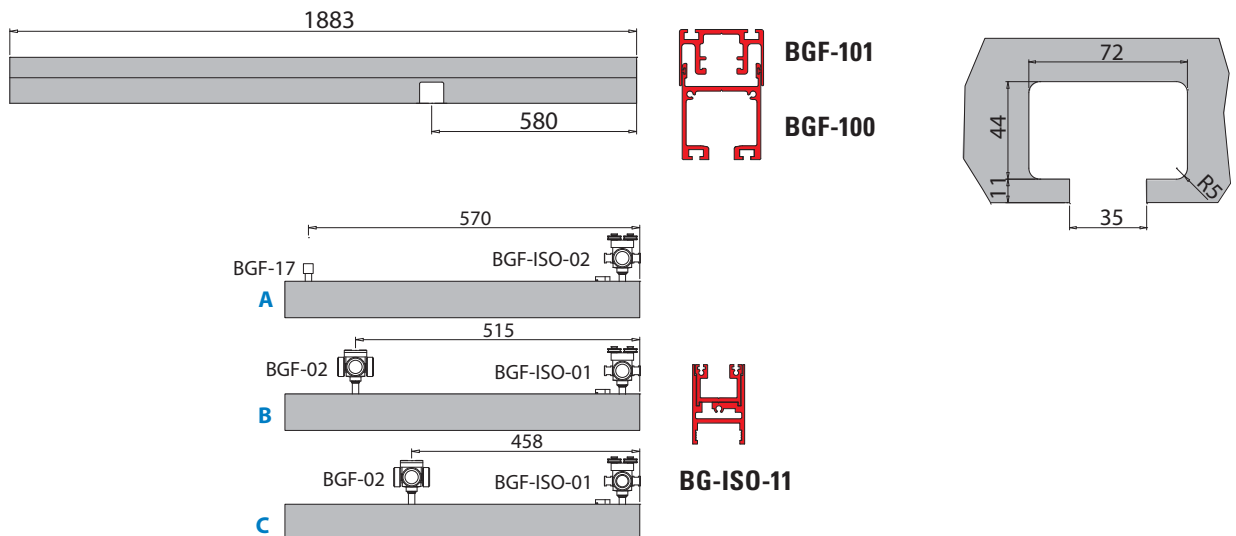

BALCONGLAS FALCE PARK-ISO

COME ASSEMBLARE LE ANTE / HOW TO ASSEMBLE THE DOORS / WIE DIE TÜREN ZUSAMMENSETZT WERDEN

	TAGLIO PROFILI PROFIL PREPARATION / PROFILBEARBEITUNG		KIT ACCESSORI ACCESSORY SETS / ZUBEHÖR SETS		ANTA COMPLETA COMPLETE DOOR / KOMPLETTE TÜR
ANTA A / DOOR A / TÜR A			BG-ISO-PAR-A-DX / BG-ISO-PAR-A-SX PORTA LATERALE A LATERAL PIVOT DOOR A DREHFLÜGEL A		

	TAGLIO PROFILI PROFIL PREPARATION / PROFILBEARBEITUNG		KIT ACCESSORI ACCESSORY SETS / ZUBEHÖR SETS		ANTA COMPLETA COMPLETE DOOR / KOMPLETTE TÜR
ANTA B / DOOR B / TÜR B			BG-ISO-PAR-B-DX / BG-ISO-PAR-B-SX ANTA INTERMEDIA B INTERMEDIATE PANEL B MITTIGE FLÜGEL B		

	TAGLIO PROFILI PROFIL PREPARATION / PROFILBEARBEITUNG		KIT ACCESSORI ACCESSORY SETS / ZUBEHÖR SETS		ANTA COMPLETA COMPLETE DOOR / KOMPLETTE TÜR
ANTA C / DOOR C / TÜR C			BG-ISO-PAR-C-DX / BG-ISO-PAR-C-SX ULTIMA ANTA C LAST PANEL C ENDFLÜGEL C		