

B-8250 CMR / B-8250-G CMR / B-8260 CMR / B-8260-G CMR

€ H.25 € H.26

• Balastra a montaggio laterale regolabile.

• Adjustable railing system, side installation.

• Verstellbares Ganzglasgeländer System Seitenmontage.

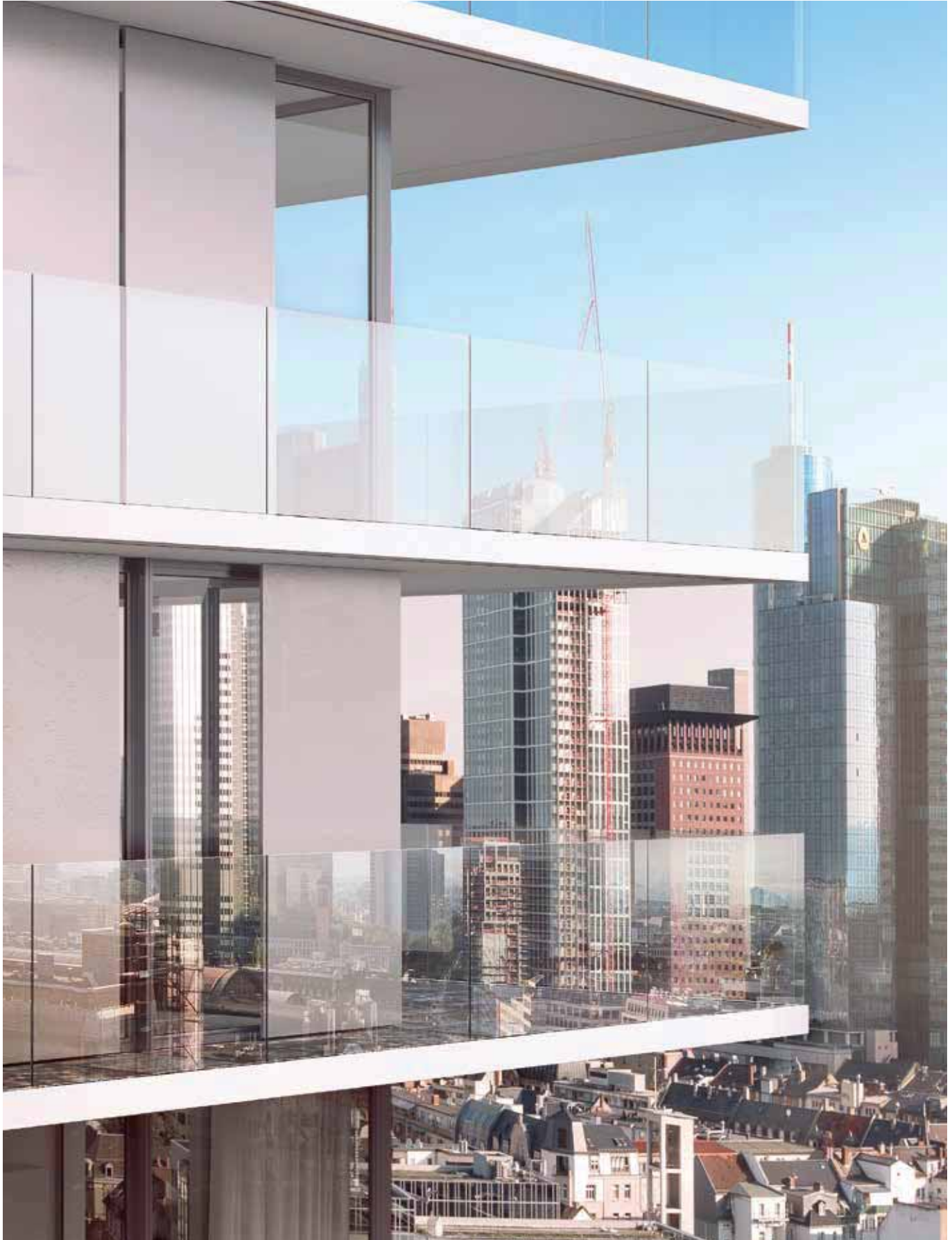

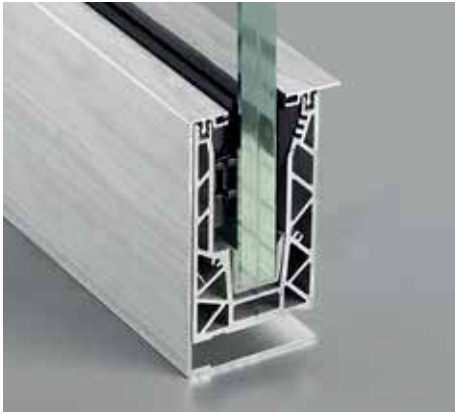

COMPONENTI / COMPONENTS / EINZELTEILE

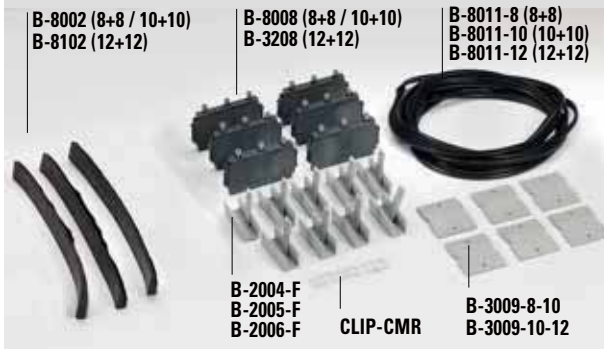
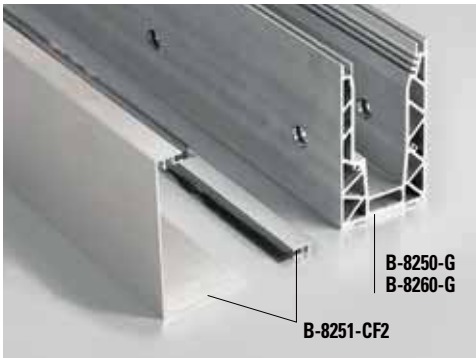

B-8250-G / B-8260-G + B-8251-CF2

- Profilo balastra + 2 Velette
- Railing profile + 2 Cover profiles
- Profil für Geländer mit 2 Abdeckungen

B-SET-CMR-8 / B-SET-CMR-10 / B-SET-CMR-12

- Set morsetti e guarnizioni
- Set clamps and gaskets
- Set Klemmen und Dichtungen

- Accessori per montaggio facile e veloce (vedi video)
- Accessories for easy and quick installation (see video)
- Zubehör für einfache und schnelle Montage (Siehe Video)

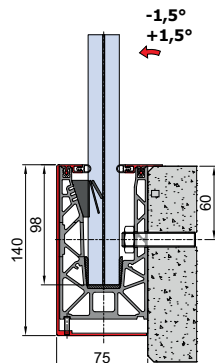
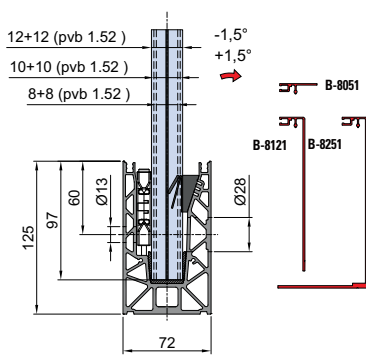

B-8250-G
B-8251-CF2

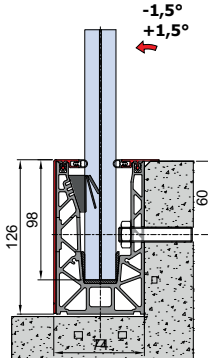

B-8250-G
B-8121+B-8051

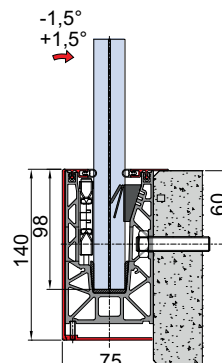

B-8260-G
B-8251-CF2

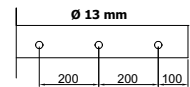

FB041P173

ESTERNO
SCALA

Set completo/mt L = 3000 mm Complete set/mt L = 3000 mm Komplett-Set L = 3000 mm	FIN. FIN. OB.	Vetro Glass Glas	Morsetti/mt Clamps/mt Klemmen/fm	Testato spinta Test side force Getestete Seitenkraft	Classe Class IT Klasse	Testato Tested Bestätigte horizontale Nutzlast
B-8250 / B-8260 SET 1,5 KN 8	AN-IXE	8+8 1,52 pvb	2	150 kg	1	1 kN/m = 100 kg/m
B-8250 / B-8260 SET 3 KN 10	AN-IXE	10+10 1,52 pvb	2	300 kg	2	2 kN/m = 200 kg/m
B-8250 / B-8260 SET 4,5 KN 12	AN-IXE	12+12 1,52 pvb	3	450 kg	3	3 kN/m = 300 kg/m
B-8250-G / B-8260-G SET 1,5 KN 8	GR	8+8 +1,52 pvb	2	150 kg	1	1 kN/m = 100 kg/m
B-8250-G / B-8260-G SET 3 KN 10	GR	10+10+1,52 pvb	2	300 kg	2	2 kN/m = 200 kg/m
B-8250-G / B-8260-G SET 4,5 KN 12	GR	12+12 1,52 pvb	3	450 kg	3	3 kN/m = 300 kg/m

SET COMPOSTO DA SET CONSISTING OF SET BESTEHEND AUS	FIN. FIN. OB.	B-8250 / B-8260 SET 1,5 KN 8	B-8250 / B-8260 SET 3 KN 10	B-8250 / B-8260 SET 4,5 KN 12	B-8250-G / B-8260-G SET 1,5 KN 8	B-8250-G / B-8260-G SET 3 KN 10	B-8250-G / B-8260-G SET 4,5 KN 12
B-8250-G / B-8260-G	GR	1 pz/pcs L = 3000 mm	1 pz/pcs L = 3000 mm	1 pz/pcs L = 3000 mm	1 pz/pcs L = 3000 mm	1 pz/pcs L = 3000 mm	1 pz/pcs L = 3000 mm
B-8251-CF2	AN-IXE	1	1	1	-	-	-
B-SET-CMR-8	-	1	-	-	1	-	-
B-SET-CMR-10	-	-	1	-	-	1	-
B-SET-CMR-12	-	-	-	1	-	-	1
B-8051-CF2 optional velette / optional cover profiles	AN-IXE	(1)	(1)	(1)	(1)	(1)	(1)
B-8121-CF2 optional velette / optional cover profiles	AN-IXE	(1)	(1)	(1)	(1)	(1)	(1)